



TEL +34 986 943 253  
EMAIL [chgrupo3@chgrupo3.com](mailto:chgrupo3@chgrupo3.com)

Comercial Hospitalaria Grupo-3, S.L.  
Rúa do Arroncal nº9, Vial C, Nave 4C  
Parque Empresarial Porto do Molle  
36350 Nigrán (Pontevedra)  
[www.chgrupo3.com](http://www.chgrupo3.com)



**Leica**  
MICROSYSTEMS

Educational Compound Microscopes

## A NEW GENERATION'S CHOICE OF INNOVATIVE EDUCATIONAL MICROSCOPES

Leica DM500 & DM750



# MADE FOR FUTURE NOBEL PRIZE WINNERS

## Science Teaching Revitalized

The more time the instructor has to teach, the more students can learn. The Leica DM500 and Leica DM750 microscopes were specifically developed to revitalize science teaching and to achieve the goal of more hands-on time for Life Science courses. With many student-friendly features and high-quality construction, the Leica DM500 and Leica DM750 invigorate science learning and teach the next generation of scientists effectively and efficiently.

### SUPERB OPTICS

- › Based on the same optical platform as Leica Microsystems' research microscope line, students enjoy outstanding optical performance with full access to virtually all accessories from Leica's microscope product line.
- › NEW! 100× dry (no oil needed) objective provides very high resolution (N.A. 0.8) while eliminating the need for oil.

### EZLITE™

- › LED illumination provides cool, white light with a lifetime of over 20 years average use. There is no need to change lamps during lab time, and this saves the expense of replacement lamps as well.
- › The cost-savings pays for several microscopes over their lifetimes.

### SAFETSTAGE™

- › Microscope stage maintains its dimension, which eliminates the chance of injury from contact with a conventional stage rack.
- › Rounded edges are easy on the skin.

### EZSTORE™

- › Integrated vertical handle provides easy carrying and lifting when storing on shelves; undercut on front of stand works in combination with the handle for safer, two-handed carrying.
- › Integrated cord wrap eliminates damage to microscope components from improper cord wrapping; vertical cord in sertion prevents the cord from pulling partially out of the stand while in storage or in use.
- › The unique shape of the microscope stand protects controls from damage when microscopes are stored side-by-side.

### EZGUIDE™

- › Student friendly slide holder helps prevent slide chipping
- › Providing power to the Leica USB cameras is extremely easy. Simply connect the camera via the provided USB cable to the 5 V/1.5 A USB connector on the rear of the Leica DM500 and Leica DM750 stand. This saves the cost of an external power supply for the camera plus reduces the complexity at the workstation.

### AGTREAT™

- › The possible contamination with germs from surfaces is of great concern, especially in educational environments. Leica Microsystems has integrated an additive to the material of all microscope touchpoints to inhibit the growth of bacteria. This helps prevent the spread of disease via the microscope surfaces and leads to a healthier laboratory environment.

### USB POWER CONNECTOR



# LEICA DM500 – SCIENCE TEACHING MADE EASY

The Leica DM500 is ideal for entry level Life Science courses. The microscope's stand provides "plug and play" capability. All students need to do is turn the power on, place the specimen slide on the stage, focus, and enjoy the view!



## READY TO WORK

- › Pre-centered, pre-focused Abbe condenser eliminates the need for adjustments



## EZTUBE™

- › Eyepieces integrated with the eyetubes prevents loss
- › Preset diopter adjustments eliminates the risk of incorrectly setting the diopters
- › Other viewing tubes are also available



## SAFER ROTATION

- › Captive thumbscrew for safer rotation of the EZTUBE™



## ALL IN ONE

- › Abbe Condenser with slot for phase contrast and darkfield sliders, including a 4 position phase slider, which offers brightfield and phase capabilities all in one slider



## PERFECT LIGHT

- › LED illumination designed to provide even lighting across the full field of view without adjustments

# LEICA DM750 – SCIENCE TEACHING FOR A NEW GENERATION

The Leica DM750 is designed specifically for the versatile needs of advanced Life Science courses and for professional training such as medical, veterinary, and dental schools.

## VERSATILE

- > Standard condenser magnifications 4× – 100×
- > Phase turret condenser for brightfield and phase contrast
- > Flip top condenser for low magnifications
- > The Leica DM750 is available with a 4 position or 5 position nosepiece



## WEAR RESISTANT

- > Special stage finish offers additional protection from friction damage



## ENERGY SAVING

- > Time delay shutoff saves energy by automatically turning off the illumination after 2 hours of no use



## A+ FOCUS, CONTRAST & ILLUMINATION

- > Weighted focus knobs provide inertia and extremely accurate focus capability
- > Koehler field diaphragm available as an option for optimum illumination and contrast



## SHARED VIEWING MADE EASY

- > Variety of viewing tubes provides free rotation while securely fixed to the stand
- > Standard viewing tubes with eyepiece locking screws prevent loss of eyepieces

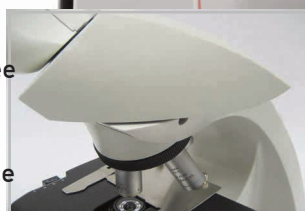

## GO WIRELESS!

The ability to share, capture, and archive images is an important part of the microscopy laboratory. The DM500 and Leica DM750 are compatible with the full range of Leica Microsystems imaging solutions, allowing you to select the camera which best suits the demands of your classroom. Keep students on topic and maximize learning time with the NEW Leica ICC50 W/ E High Definition Wireless camera module.

### THE ICC50 W/ E CAMERA MODULE - INTEGRATED & MODULAR

- › In Ethernet mode, the connection to the camera is provided through your own network, allowing a maximum number of users to connect to the camera. To use this to full extent devices have to be on to same network as the microscope.
  - › In USB mode you can connect your PC directly via USB cable to the camera, which is helpful when you aim for fastest images e.g. of moving samples.
  - › Computer users can use the Leica Imaging software to connect to the camera and work with the images. For PC use Leica Application Suite software, and use Leica Acquire for MAC.
  - › Use lots of options with Leica AirLab App: It enables camera setup, annotations, measuring, image capture, and sharing to email, photo folders, or other social media connections.
- Leica AirLab App is available free of charge for Android and iOS devices. It is very flexible if there is no PC or mobile device around: Just capture images directly onto a memory card.
- It is also possible to tune camera settings conveniently, capture images onto the SD card, and view the SD card gallery – all possible with the remote.
- Project your images: Use the HDMI port for screen projections or output to HD screens.
- You don't need any extra power cables: The camera is powered directly from the microscope stand with a USB cable.

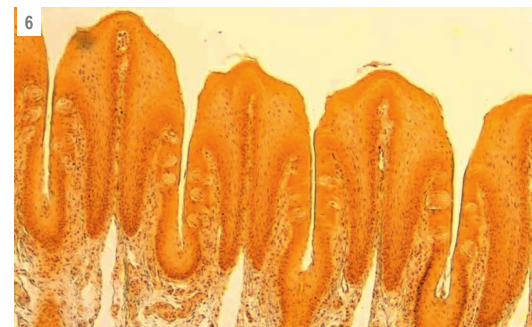
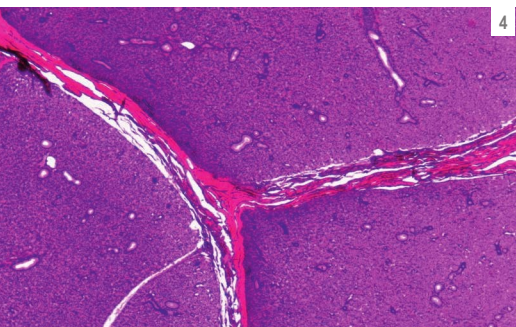
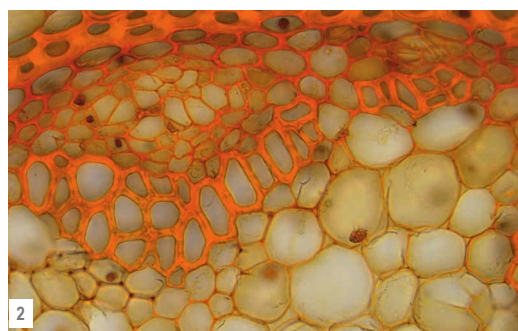
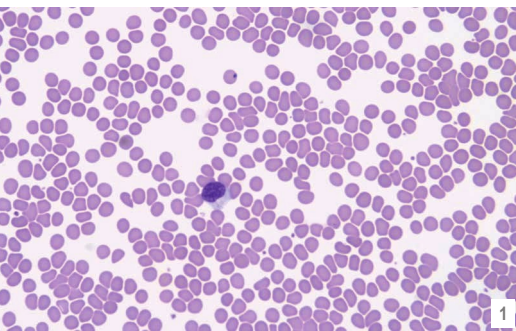



Students can connect to the Leica ICC50 W either through its **internal Wi-Fi signal** using Wi-Fi mode or through the facilities' network using Ethernet mode.



The ICC50 **Exclusively** uses your facilities' network (WLAN or LAN) to allow students to connect to the camera. This is an ideal solution if you don't want to add additional Wi-Fi access points to your network.



- 1: Human Blood
- 2: Convallaria – Lily of the Valley
- 3: Giant Chromosomes
- 4: Parotid Gland
- 5: Pine
- 6: Taste Buds

Leica DM750 with Leica ICC50 W digital microscope camera

# SYSTEM DIAGRAM

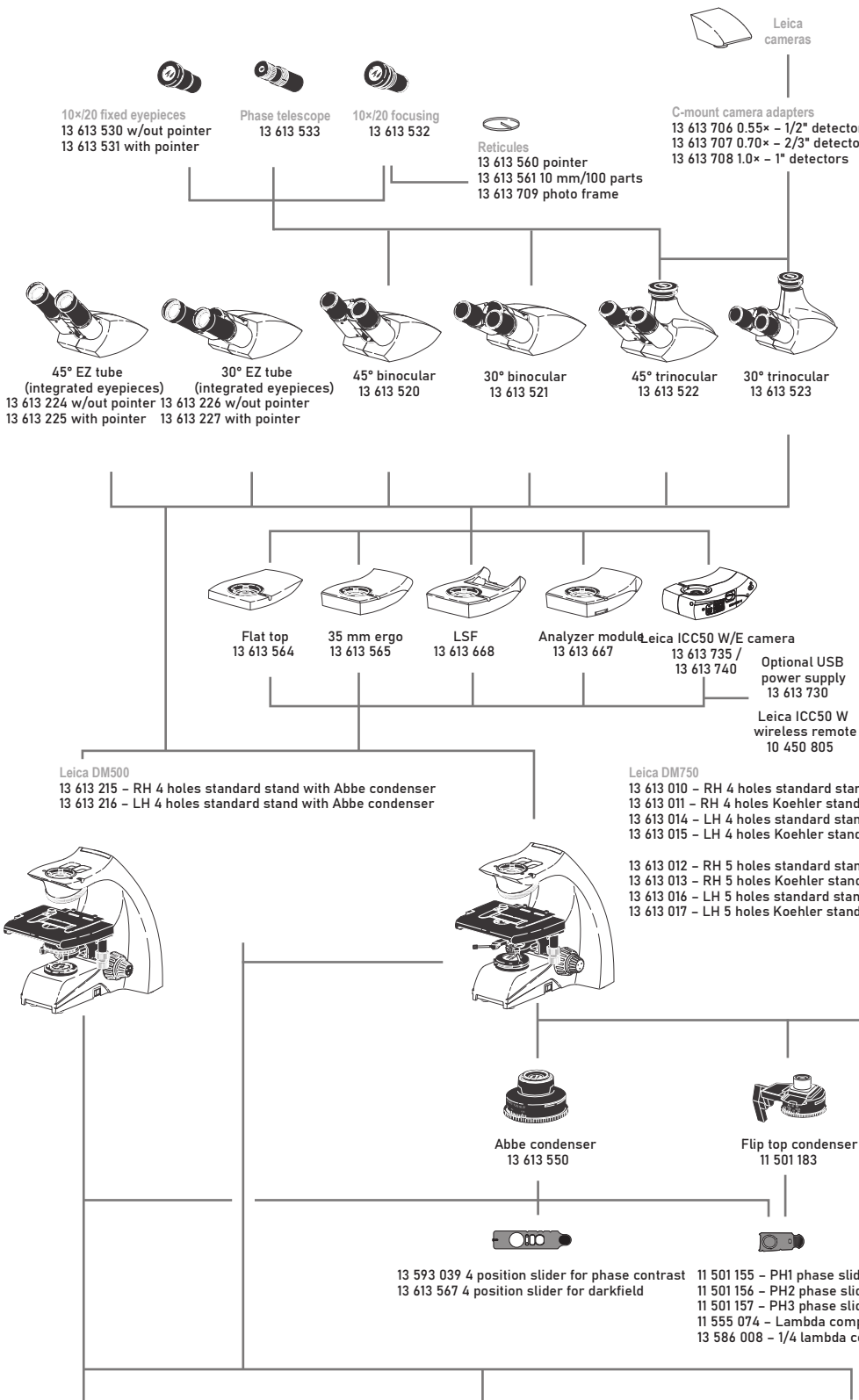

- 13 613 563
- 13302138946910
- 13 613 571
- 13 613 572
- 13 613 584
- 13 613 210-100
- 13 613 510-100
- 13 613 735-100
- 13 613 573

- 11 555 045
- 11 555 079
- 11 555 080

- 13 613 262
- 13 613 261
- 13 614 800
- 11 513 106
- 11 505 091
- 11 505 507
- 13 613 566
- 13 613 263
- 10 450 245
- 13 613 562

- 13 613 900
- 13 613 901
- 13 613 902
- 13 613 903
- 13 613 904
- 13 613 905
- 13 613 906
- 13 613 907
- 13 613 908
- 13 613 909
- 13 613 910
- 13 613 911
- 13 613 912

**Replacements**  
 Eyeguard pair  
 Fuses for Leica DM500, Leica DM750  
 Thumbscrew pair for Leica DM750 condenser mount  
 Set screw pair for Leica DM750 condenser mount  
 Dust cover Leica DM500, Leica DM750  
 Leica DM500 User documents  
 Leica DM750 User documents  
 Leica ICC50 W user documents  
 Add-on lens for condensers for Leica DM750 (included with stand)

**Analyzer module sliders**  
 Fixed analyzer slider  
 180° rotatable analyzer slider  
 360° rotatable analyzer slider

**Others**  
 Captive thumbscrew for EZ tube  
 Rubber grips for X/Y controls  
 Immersion oil  
 Stage micrometer  
 Diffuser slider for using 2.5× objective with Abbe condenser  
 Auxilliary lens for using 2.5× objective with 11 501 183 flip top condenser  
 32 mm filter holder  
 Hard carrying case  
 Soft carrying case  
 Simple pol kit

**International power cords**

U.S.	
Europe Continental	
U.K.	
Switzerland	
Denmark	
Italy	
Australia	
China	
Japan	
Israel	
South Africa	
India	
Argentina	

- Leica DM750**  
 13 613 010 – RH 4 holes standard stand  
 13 613 011 – RH 4 holes Koehler stand  
 13 613 014 – LH 4 holes standard stand  
 13 613 015 – LH 4 holes Koehler stand  
 13 613 012 – RH 5 holes standard stand  
 13 613 013 – RH 5 holes Koehler stand  
 13 613 016 – LH 5 holes standard stand  
 13 613 017 – LH 5 holes Koehler stand

- Plan objectives**  
 13 613 240 – Plan 4×/0.10 NA, 26.2 mm\*  
 13 613 241 – Plan 10×/0.22 NA, 7.8 mm\*  
 13 613 242 – Plan 40×/0.65 NA, 0.31 mm\*  
 13 613 243 – Plan 100×/1.25 NA, 0.10 mm\*, oil  
 \* working distance

- HI Plan objectives**  
 11 506 226 – HI Plan 4×/0.10 NA, 18.0 mm\*  
 11 506 228 – HI Plan 10×/0.25 NA, 12.0 mm\*  
 11 506 276 – HI Plan 20×/0.40 NA, 0.92 mm\*  
 11 506 236 – HI Plan 40×/0.65 NA, 0.36 mm\*  
 11 506 237 – HI Plan 63×/0.75 NA, 0.31 mm\*  
 11 506 238 – HI Plan 100×/1.25 NA, 0.10 mm\*, oil  
 11 506 386 – HI Plan 100×/0.80 NA, 0.3 mm\* dry objective  
 \* working distance

- HI Plan phase objectives**  
 11 506 230 – HI Plan phase 10×/0.25 NA, 12.0 mm\*  
 11 506 278 – HI Plan phase 20×/0.40 NA, 0.92 mm\*  
 11 506 240 – HI Plan phase 40×/0.65 NA, 0.36 mm\*  
 11 506 241 – HI Plan phase 100×/1.25 NA, 0.10 mm\*, oil  
 \* working distance

# PRECONFIGURED OUTFITS

OUTFIT ORDERING NUMBER	13 613 207	13 613 208	13 613 403	13 613 406	13 613 001	13 613 004	13 613 002	13 613 005
	DM500	DM500	DM750	DM750	DM750	DM750	DM750	DM750
<b>STANDS</b>								
13 613 215 DM500 RH Stand with Abbe condenser	X	X						
13 613 010 DM750 RH Stand			X	X	X	X		
13 613 011 DM750 RH Stand Koehler							X	X
<b>TUBES</b>								
13 613 224 45° EZ tube	X		X					
13 613 225 45° EZ tube with pointer		X		X				
13 613 520 45° binocular tube					X	X	X	X
<b>EYEPIECES</b>								
13 613 530 10×/20 eyepiece w/eyeguard					X		X	
13 613 531 10×/20 pointer eyepiece w/eyeguard						X		X
13 613 532 10×/20 focusing eyepiece w/eyeguard					X	X	X	X
<b>CONDENSERS</b>								
13 613 550 Abbe condenser 0.9 Dry/1.25 oil			X	X	X	X	X	X
<b>OBJECTIVES</b>								
13 613 240 Plan 4×/0.10 NA, 26.2 mm W.D.	X	X	X	X				
13 613 241 Plan 10×/0.22 NA, 7.8 mm W.D.	X	X	X	X				
13 613 242 Plan 40×/0.65 NA, 0.31 mm W.D.	X	X	X	X				
13 613 243 Plan 100×/1.25 NA, 0.10 mm W.D., oil	X	X	X	X				
11 506 226 HI Plan 4×/0.10 NA, 18.0 mm W.D.					X	X	X	X
11 506 228 HI Plan 10×/0.25 NA, 12.0 mm W.D.					X	X	X	X
11 506 236 HI Plan 40×/0.65 NA, 0.36 mm W.D.					X	X	X	X
11 506 238 HI Plan 100×/1.25 NA, 0.10 mm W.D., oil					X	X	X	X
13 614 800 Immersion oil	X	X	X	X	X	X	X	X

POWER CORD NOT INCLUDED: Must be ordered separately

# DIMENSIONS LEICA DM500 / DM750

Dimensions in mm/inch

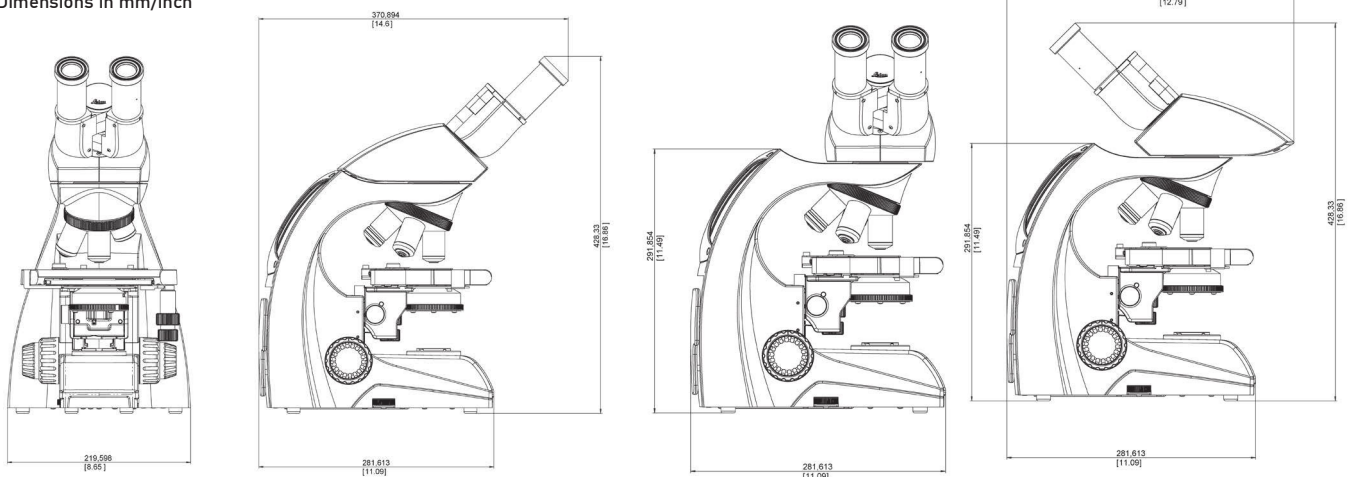

# SPECIFICATIONS LEICA DM500 / DM750

	DM500	DM750		DM500	DM750
<b>SEPARATE EYEPIECES</b>			<b>SAFETSTAGE™</b>		
High eyepoint	X	X	Stage surface 185 mm (150 mm front) x 140 mm deep	X	X
10×/20 (20 mm field of view)	X	X	Rounded stage edges	X	X
Available with or without pointer	X	X	Non extending rack	X	X
Available fixed or focusing	X	X	Verniers for X/Y coordinates	X	X
Focusing eyepieces with reticule holder for 24.5 mm reticles	X	X	Wear resistant stage surface	X	X
Foldable eyeguards	X	X	<b>CONDENSER</b>		
30 mm mounting diameter	X	X	Prefocused and precentered Abbe condenser	X	
<b>EZTUBE™</b>			Centerable and focusable condenser mount		X
Preset diopters for corrected vision	X	X	Slot in Abbe condenser for contrast sliders (phase, darkfield, compensator)	X	X
45 degree viewing angle	X	X	Magnification labels on condenser	X	X
10×/20 (20 mm field of view)	X	X	Standard Leica condenser mount for condensers (Abbe, turret, flip top, etc.)		X
Attaches to stand with set screw	X	X	<b>FOCUS</b>		
Captive thumbscrew available for safer rotation	X	X	Low position focus controls	X	X
Eyepieces are integrated with tube	X	X	Self adjusting focus mechanism	X	X
Available with pointer and without pointer	X	X	300 microns per fine focus rotation	X	X
Interpupillary distance range 52 mm – 75 mm	X	X	Calibrated in 3 micron increments	X	X
<b>OTHER VIEWING TUBES FOR SEPARATE EYEPIECES</b>			Weighted focus knobs		X
45 degree, 30 degree, trinocular	X	X	<b>EZLITE™</b>		
Maximum field of view 20 mm	X	X	Preset field aperture only	X	
Rotatable dovetail	X	X	Available with or without adjustable Koehler field diaphragm		X
Leica tube dovetail standard	X	X	LED Illumination – 6 000 K temp, 25 000 h life at full intensity		X
Eyepiece locking screw	X	X	Continuous intensity adjustment	X	X
Interpupillary distance range 52 mm – 75 mm	X	X	Illumination sufficient for viewing at lowest intensity	X	X
<b>STAND</b>			Simple polarizing kit available	X	X
Stand shape protects controls	X	X	2 hour Auto Off (can be disabled or enabled)		X
Stand construction – die-cast aluminium	X	X	Auto Off default: 4 hole stands enabled, 5 hole stands disabled		X
External fuses	X	X	<b>IMAGING</b>		
Knurled nosepiece	X	X	Trinocular tubes available (50 %/50 % light split)	X	X
4 position nosepiece only	X		C-mount adapters with standard Leica mount	X	X
4 or 5 position nosepiece available		X	Leica ICC50 W intermediate camera module (50 %/50 % light split)		X
Drop in holder for 32 mm mounted or unmounted filters	X	X	<b>INTERMEDIATE MODULES</b>		
5 V/1.5 A USB power supply to power camera	X	X	35 mm intermediate ergo module available	X	X
<b>EZSTORE™</b>			15 mm flat top module	X	X
Vertical handle	X	X	Module for LSF reflected light illuminator	X	X
Undercut in front of stand	X	X	Analyzer module	X	X
Cord wrap	X	X	<b>AGTREAT™</b>		
Vertical cord attachment to stand	X	X	Anti microbial treatment	X	X
<b>OBJECTIVES</b>			<b>CERTIFICATIONS</b>		
Infinity optics platform	X	X	cULus, CE, RoHS	X	X
100× dry objective with N.A. 0.8 (no correction collar)	X	X	Main optical components meet ISO 9022-11 for Mould Growth		X
Objective labeling laser engraved (HI Plans)	X	X	<b>SHIPPING</b>		
M25 nosepiece thread	X	X	Dimensions: 40 cm x 37 cm x 39 cm (HxDxW)	X	X
<b>EZGUIDE™</b>			Weight: 9 kg	X	X
One-handed slide loading	X	X			
26 mm x 76 mm stage travel	X	X			

# CLEAN AND GREEN



WE ACTIVELY IMPLEMENT WAYS TO MAKE OUR ENVIRONMENT

CLEANER AND SAFER FOR THIS GENERATION AND THE NEXT. SEE MORE AT [WWW.LEICA-MICROSYSTEMS.COM/EDUCATION](http://WWW.LEICA-MICROSYSTEMS.COM/EDUCATION)

- 
- › All packaging is completely recyclable
  - › No lead content in any of the glass components
  - › LED illumination consumes approximately 80 % less energy than standard halogen illumination
  - › The time delay shut-off feature found on the Leica DM750 ensures no energy is wasted
  - › Constantly optimizing our logistics chain keeps the CO<sub>2</sub> print as low as possible
  - › AgTreat™ helps prevent the spread of disease via microscope surfaces and leads to a healthier laboratory environment
  - › All products have been tested by independent safety laboratories and carry the cULus and CE mark to indicate their design for safety
  - › All products are RoHS compliant, which means all electrical components meet restrictions on the use of hazardous substances
  - › Interactive tour of the Leica DM500 and Leica DM750
  - › Leica E-Series stereomicroscopes for low magnification inspection, dissecting, and image capture
  - › Leica DM750 P Polarizing Microscope for Earth and Materials Science education
  - › Leica DM750 M Microscope for Metallography
  - › Selection of higher level microscopes for research
  - › A selection of instructional booklets, which are free of charge



TEL +34 986 943 253  
EMAIL [chgrupo3@chgrupo3.com](mailto:chgrupo3@chgrupo3.com)

Comercial Hospitalaria Grupo-3, S.L.  
Rúa do Arroncal nº9, Vial C, Nave 4C  
Parque Empresarial Porto do Molle  
36350 Nigrán (Pontevedra)  
[www.chgrupo3.com](http://www.chgrupo3.com)



Leica Microsystems (Schweiz) AG · Max-Schmidheiny-Strasse 201 · 9435 Heerbrugg, Switzerland  
T +41 71 726 34 34 · F +41 71 726 34 44

[www.leica-microsystems.com](http://www.leica-microsystems.com)

CONNECT  
WITH US!

